

IP 66



IK 10

**CONSTRUCTION**

Material: polycarbonate / polyamide

The exclusive interlock device is equipped with the plug and socket device. The switch is not turned on if it is not rotated and the plug can not be pulled out when the switch is turned on after the plug is inserted into the socket, which the non-live action is realized.

The protective covers are equipped on both plug and socket, which ensure the reliability of the protective degree.

Therefore, the plug and socket device can be used under the extreme conditions.

TECHNICAL DATA

Certificate:	FIDI 21 ATEX 0052U, FIDI 21 ATEX 0049X, FIDI 21 ATEX 0050X, FIDI 21 ATEX 0051U
Marking:	0722
Apparatus category:	II 2GD
Marking of explosion protection:	Ex db eb IIC T6...T5 Gb Ex tb IIIC T80°C... T95°C Db Ex db eb IIC Gb Ex tb IIIC Db
Ambient temperature:	$-40^{\circ}\text{C} \leq T_{\text{amb}} \leq +45^{\circ}\text{C}/+55^{\circ}\text{C}$
Degree of protection:	IP 66
Impact resistance:	IK10
Cable entries:	Wall type socket: 1xM25 cable gland (cable diameter 8-17 mm) Coupler type socket: cable diameter 8-18.5 mm Plug: cable diameter 8-18.5 mm



Wall socket



Coupler socket



Panel socket



Plug







Plug with protective cover

- 16 A to 32 A
- 50V - 690 V
- All sockets incorporate switching technology that prevents removal of the plug under electrical load and does not disturb the potentially explosive atmospheres
- Small force of inserting and pulling

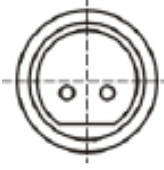
Plugs and sockets





MODEL CODE T0251 16 A 2P/3P/4P/5P

DESCRIPTION	PIN configuration	ORDER CODE
20-25 VAC 16 A 2P [min order qty is 20pcs]		
Wall socket		R-2P-16A-25VAC
Panel socket		F-2P-16A-25VAC
Coupler socket		C-2P-16A-25VAC
Plug		P-2P-16A-25VAC
Plug with cap		P-C-2P-16A-25VAC
40-50 VAC 16 A 2P [min order qty is 20pcs]		
Wall socket		R-2P-16A-50VAC
Panel socket		F-2P-16A-50VAC
Coupler socket		C-2P-16A-50VAC
Plug		P-2P-16A-50VAC
Plug with cap		P-C-2P-16A-50VAC
20-50 VDC 16 A 2P [min order qty is 20pcs]		
Wall socket		R-2P-16A-50VDC
Panel socket		F-2P-16A-50VDC
Coupler socket		C-2P-16A-50VDC
Plug		P-2P-16A-50VDC
Plug with cap		P-C-2P-16A-50VDC
110-130 V 16 A 3P [min order qty is 20pcs]		
Wall socket		R-3P-16A-130V
Panel socket		F-3P-16A-130V
Coupler socket		C-3P-16A-130V
Plug		P-3P-16A-130V
Plug with cap		P-C-3P-16A-130V
200-250 V 16 A 3P		
Wall socket		R-3P-16A-250V
Panel socket		F-3P-16A-250V
Coupler socket		C-3P-16A-250V
Plug		P-3P-16A-250V
Plug with cap		P-C-3P-16A-250V



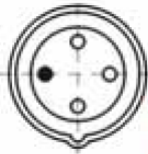

All technical data is relevant at the time of print.

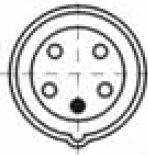
T0251 / T0252

MODEL CODE T0251 16 A 2P/3P/4P/5P

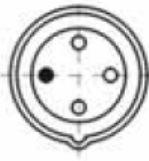
DESCRIPTION	PIN configuration	ORDER CODE
200-250 V 16 A 4P [min order qty is 20pcs]		
Wall socket		R-4P-16A-250V
Panel socket		F-4P-16A-250V
Coupler socket		C-4P-16A-250V
Plug		P-4P-16A-250V
Plug with cap		P-C-4P-16A-250V
380-415 V 16 A 4P [min order qty is 20pcs]		
Wall socket		R-4P-16A-415V
Panel socket		F-4P-16A-415V
Coupler socket		C-4P-16A-415V
Plug		P-4P-16A-415V
Plug with cap		P-C-4P-16A-415V
480-500 V 16 A 4P [min order qty is 20pcs]		
Wall socket		R-4P-16A-500V
Panel socket		F-4P-16A-500V
Coupler socket		C-4P-16A-500V
Plug		P-4P-16A-500V
Plug with cap		P-C-4P-16A-500V
600-690 V 16 A 4P [min order qty is 20pcs]		
Wall socket		R-4P-16A-690V
Panel socket		F-4P-16A-690V
Coupler socket		C-4P-16A-690V
Plug		P-4P-16A-690V
Plug with cap		P-C-4P-16A-690V
200-250 V 380-415 V 16 A 5P		
Wall socket		R-5P-16A-415V
Panel socket		F-5P-16A-415V
Coupler socket		C-5P-16A-415V
Plug		P-5P-16A-415V
Plug with cap		P-C-5P-16A-415V

Plugs and sockets

DESCRIPTION	PIN configuration	ORDER CODE
200-250 V 32 A 4P [min order qty is 20pcs]		
Wall socket		R-4P-32A-250V
Panel socket		F-4P-32A-250V
Coupler socket		C-4P-32A-250V
Plug		P-4P-32A-250V
Plug with cap		P-C-4P-32A-250V
380-415 V 32A 4P [min order qty is 20pcs]		
Wall socket		R-4P-32A-415V
Panel socket		F-4P-32A-415V
Coupler socket		C-4P-32A-415V
Plug		P-4P-32A-415V
Plug with cap		P-C-4P-32A-415V
480-500 V 32 A 4P [min order qty is 20pcs]		
Wall socket		R-4P-32A-500V
Panel socket		F-4P-32A-500V
Coupler socket		C-4P-32A-500V
Plug		P-4P-32A-500V
Plug with cap		P-C-4P-32A-500V
600-690 V 32 A 4P [min order qty is 20pcs]		
Wall socket		R-4P-32A-690V
Panel socket		F-4P-32A-690V
Coupler socket		C-4P-32A-690V
Plug		P-4P-32A-690V
Plug with cap		P-C-4P-32A-690V
200-250 V 380-415 V 32 A 5P		
Wall socket		R-5P-32A-415V
Panel socket		F-5P-32A-415V
Coupler socket		C-5P-32A-415V
Plug		P-5P-32A-415V
Plug with cap		P-C-5P-32A-415V

T0251 / T0252

DIMENSION type T0251 / 16 A

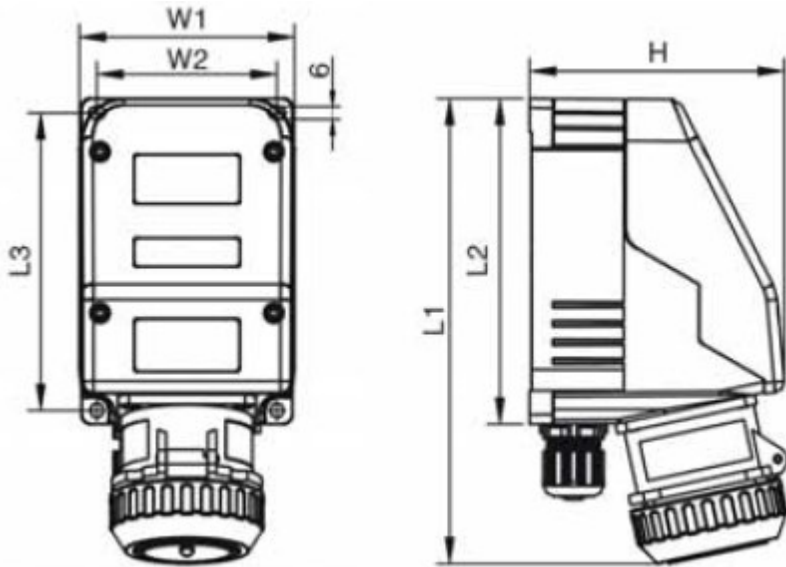

WALL SOCKET (all dimension in mm)

Poles	W1	W2	L1	L2	L3	H
2P/3P	103	86	223	156	142	122
4P/5P	123	106	241	176	163	147

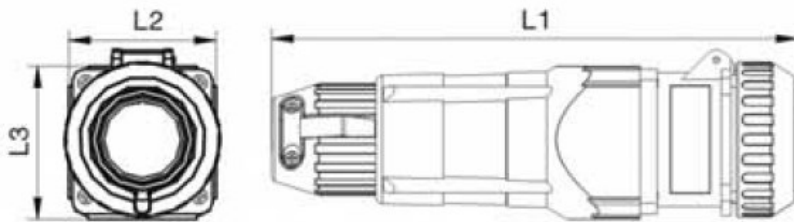

COUPLER SOCKET (all dimension in mm)

Poles	L1	L2	L3
2P/3P	247	69	72
4P/5P	279	90	93

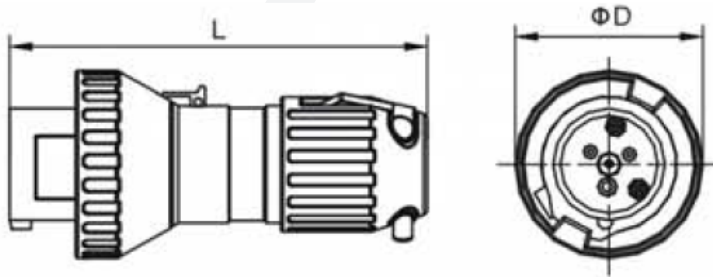

PLUG (all dimension in mm)

Poles	ΦD	L
2P/3P	73	163
4P	77	187
5P	84	187

Plugs and sockets

DIMENSION type T0252 / 32 A

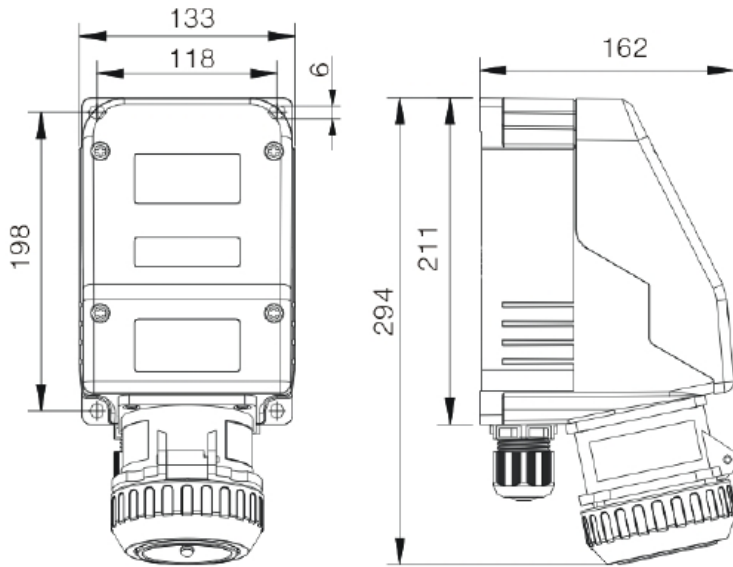

WALL SOCKET (all dimension in mm)

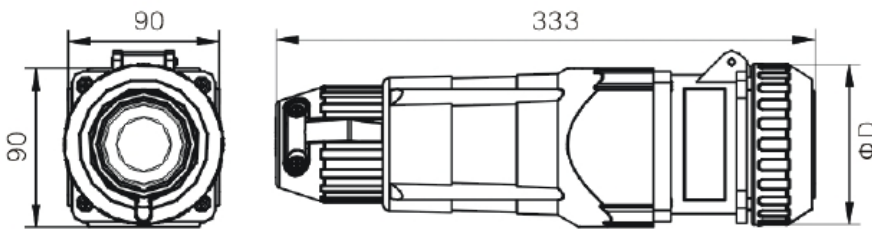

COUPLER SOCKET (all dimension in mm)

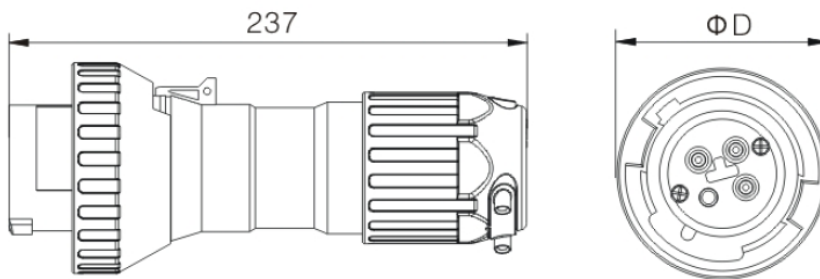

PLUG (all dimension in mm)

D 4P - $\phi 96$ mm
D 5P - $\phi 101$ mm